

# QUATECH

## QSP-100 Four Channel Asynchronous RS-232 PCMCIA Adapter

for PCMCIA Card Standard compatible machines

*INTERFACE CARDS FOR IBM PC/AT AND PS/2*

## User's Manual

QUATECH, INC.  
662 Wolf Ledges Parkway  
Akron, Ohio 44311

TEL: (330) 434-3154  
FAX: (330) 434-1409  
[www.quatech.com](http://www.quatech.com)

# Warranty Information

Quatech Inc. warrants the QSP-100 to be free of defects for five (5) years from the date of purchase. Quatech Inc. will repair or replace any adapter that fails to perform under normal operating conditions and in accordance with the procedures outlined in this document during the warranty period. Any damage that results from improper installation, operation, or general misuse voids all warranty rights.

The authors have taken due care in the preparation of this document and any associated software program(s). In no event will Quatech Inc. be liable for damages of any kind, incidental or consequential, in regard to or arising out of the performance or form of the materials presented herein and in the program(s) accompanying this document. No representation is made regarding the suitability of this product for any particular purpose.

Quatech Inc. reserves the right to edit or append to this document or the product(s) to which it refers at any time and without notice.

Please complete the following information and retain for your records. Have this information available when requesting warranty service.

Date of purchase: \_\_\_\_\_

Model Number: QSP-100

Product Description: 4 Channel Asynchronous RS-232  
Communications Adapter

Serial Number: \_\_\_\_\_

# Table Of Contents

<b>1. Introduction</b> .....	2
<b>2. DOS / Windows 3.x Installation</b> .....	3
<b>2.1 QSP-100 Client Driver for DOS</b> .....	4
<b>2.2 Client Driver Installation</b> .....	4
<b>2.4 Command Line Options</b> .....	5
1.1.1.1 Example 1 .....	6
1.1.1.2 Example 2 .....	6
1.1.1.3 Example 3 .....	7
1.1.1.4 Example 4 .....	7
1.1.1.5 Example 5 .....	7
1.1.1.6 Example 6 .....	8
1.1.1.7 Example 7 .....	8
<b>2.5 Common Problems</b> .....	9
<b>2.6 QSP-100 Enabler for DOS</b> .....	9
<b>2.7 Command Line Options</b> .....	11
1.1.1.1 Example 1 .....	12
1.1.1.2 Example 2 .....	12
1.1.1.3 Example 3 .....	12
1.1.1.4 Example 4 .....	13
1.1.1.5 Example 5 .....	13
1.1.1.6 Example 6 .....	13
<b>2.8 Common Problems</b> .....	14
<b>3.1 Command Line Options</b> .....	16
<b>3.2 Configuring With "System Assigned" Resources</b> .....	16
1.1.1.1 Example 1 .....	16
1.1.1.2 Example 2 .....	16
<b>3.3 Configuring With "User Assigned" Resources</b> .....	17
1.1.1.1 Example 1 .....	17
1.1.1.2 Example 2 .....	17
<b>3.4 Advanced Configuration Topics</b> .....	18
<b>3.5 Monitoring The Status Of PCMCIA Cards</b> .....	19
<b>3.6 Common Problems</b> .....	20
<b>4.1 Installing a Quatech QSP-100 Under Windows 95.</b> .....	21
<b>4.2 Viewing the QSP-100 Resource Settings</b> .....	22
<b>4.3 Changing Configuration of the QSP-100.</b> .....	23
<b>5 Installing QSP-100 under Windows NT</b> .....	24
<i>5.1 Installing QSP-100 Under Windows NT</i> .....	24
<b>6 Windows CE</b> .....	28
<b>6.1 Installing Quatech PCMCIA Cards under Windows CE</b> .....	28

<b>7. Hardware Information</b> .....	30
<b>8. EXTERNAL CONNECTIONS</b> .....	31
<b>9. Specifications</b> .....	33

# 1. Introduction

---

The Quatech QSP-100 provides four independent RS-232 asynchronous serial communications interfaces for systems equipped with PCMCIA Type II and/or Type III expansion sockets. The QSP-100 is a PCMCIA Type II (5 mm) card and is PCMCIA PC Card Standard Specification 2.1 compliant.

The QSP-100's serial ports are implemented using 16C550 Universal Asynchronous Receiver/Transmitters (UARTs) which are the recommended communications interface for multitasking environments and with applications involving high data transfer rates.

The QSP-100's four serial ports are addressed in a single 32 byte I/O block for simplified programming and all four channels share a common interrupt (IRQ). A special interrupt status register is also available to simplify the software required to service multiple serial ports in an interrupt driven environments.

## 2. DOS / Windows 3.x Installation

---

Two configuration software programs are provided with the QSP-100: a Client Driver, QSP100CL.SYS, and a card Enabler, QSP100EN.EXE. Both of these programs are executed from DOS (before entering Windows) and allow operation of the QSP-100 in both the DOS and Windows 3.x environments. For optimal operation, however, the Client Driver is the preferred method of installation and configuration. The table below highlights the differences between these programs.

Client Driver (recommended)	Enabler (not recommended)
File name: QSP100CL.SYS	File name: QSP100EN.EXE
File type: DOS device driver	File type: DOS executable
Interfaces to PCMCIA Card and Socket Services software (PCMCIA host adapter independent)	Interfaces directly to Intel 82365SL and other PCIC compatible PCMCIA host adapters
Allows automatic configuration of QSP-100 adapters upon insertion (Hot Swapping)	Does not support automatic configuration of QSP-100 adapters upon insertion (Hot Swapping)
Requires PCMCIA Card and Socket Services software	Does not require PCMCIA Card and Socket Services software

Figure 1. Client Driver versus Enabler for DOS/Windows 3.x.

Card and Socket Services software is commercially available from several vendors for most desktop and laptop PCs. If you are unsure whether Card and Socket Services software is currently installed on your system, install the QSP-100 Client Driver as discussed in following section. When loaded, the Client Driver will display an error message if Card and Socket Services software is not detected.

## 2.1 QSP-100 Client Driver for DOS

In order to use the QSP-100 Client Driver, the system must be configured with Card and Socket Services software. Card and Socket Services software is not provided with the QSP-100 but is available from Quatech.

### **IMPORTANT:**

Some versions of Card and Socket Services dated before 1993 do not support general purpose I/O cards. If after careful installation of the Client Driver the QSP-100 does not configure or operate properly, an updated version of Card and Socket Services may be required. Card and Socket Services software is available from Quatech Inc.

## 2.2 Client Driver Installation

The following procedure is used to install the QSP-100 Client Driver:

1. Copy the file QSP100CL.SYS from the QSP-100 distribution Quatech COM CD onto the system's hard drive.
2. Using an ASCII text editor, open the system's CONFIG.SYS file located in the root directory of the boot drive.
3. Locate the line(s) in the CONFIG.SYS file where the Card and Socket Services software is installed.
4. **AFTER** the line(s) installing the Card and Socket Services software, add the following line to the CONFIG.SYS file:

DEVICE =

*drive:\path\QSP100CL.SYS options*

where *options* are the QSP-100 Client Driver command line options discussed on the following pages.

5. Save the CONFIG.SYS file and exit the text editor.

6. Insert the QSP-100 into one of the system's PCMCIA slots.

**NOTE:** Since the QSP-100

Client Driver supports "Hot Swapping", it is not necessary to have the QSP-100 installed when booting the system. By inserting the card before booting, however, the Client Driver will report the adapter configuration during the boot process thereby verifying the changes made to the CONFIG.SYS.

7. Reboot the system and note the message displayed when the QSP-100 Client Driver is loaded. If the Client Driver reports an "invalid command line option", correct the entry in the CONFIG.SYS file and reboot the system again. If the Client Driver reports "Card and Socket Services not found", a version of Card and Socket Services must be installed on the system or the QSP-100 Enabler program must be used to configure the adapter. If the Client Driver reports the desired adapter configuration, the installation process is complete and the QSP-100 may be removed and / or inserted from the system as desired. On each insertion into the PCMCIA socket, the QSP-100 will be automatically re-configured according to the command line options.

## 2.4 Command Line Options

The QSP-100 Client Driver accepts up to eight command line arguments from the user to determine the configuration of the QSP-100. If any arguments are provided, the Client Driver will attempt to configure any QSP-100s with the options specified in the order they are entered on the command line. Each argument must be enclosed in parenthesis and must be separated from other arguments by a space on the command line. Within each argument, any or all of the following parameters may be specified using a comma (no spaces) to separate each parameter:

*Baddress* specifies the base I/O address of the QSP-100 in hexadecimal and must reside on an even 32-byte (20H) boundary. If this option is omitted, a base address will be assigned by Card and Socket Services.

*Iirq* specifies the interrupt level (IRQ) of the QSP-100 in decimal. *irq* must be one of the following values: 3, 4, 5, 7, 9, 10, 11, 12, 14, 15, or 0 if no IRQ is desired. If this option is omitted, an interrupt level will be assigned by Card and Socket Services.

*Ssocket* specifies which PCMCIA socket the QSP-100 must be inserted into for this configuration argument to be used. *socket* must be in the range 0 - 15. If this option is omitted, the configuration argument will apply to QSP-100s inserted into any socket.

*U* instructs the Client Driver to disable the QSP-100's interrupt status register and enable the Scratchpad registers of the individual UARTs. This option is only required in very rare cases where an application program requires access to the UART's Scratchpad register. If

this option is omitted, the QSP-100's interrupt status register is enabled and the UARTs' Scratchpad registers are disabled.

- E instructs the Client Driver to update the BIOS equipment list with the addresses assigned to the QSP-100. This option is only required in very rare cases where an application program checks the BIOS equipment list to determine the address of a COM port. If this option is omitted, the BIOS equipment list is not updated.

#### 1.1.1.1Example 1

```
DEVICE = C:\QSP-100\QSP100CL.SYS
```

In example 1, no command line arguments are specified. The Client Driver will configure a QSP-100 inserted into any socket with a base address and IRQ assigned by Card and Socket Services. The QSP-100's interrupt status register will be enabled and the BIOS equipment list will not be updated.

#### 1.1.1.2Example 2

```
DEVICE = C:\QSP-100\QSP100CL.SYS (b300)
```

In example 2, a single command line argument is provided. The Client Driver will attempt to configure a QSP-100 inserted into any socket with a base address of 300H and an IRQ assigned by Card and Socket Services. If address 300H is unavailable, the QSP-100 will not be configured. If the Client Driver can successfully configure the QSP-100, its interrupt status register will be enabled and the BIOS equipment list will not be updated.

### 1.1.1.3Example 3

```
DEVICE = C:\QSP-100\QSP100CL.SYS (s0,b300,i5)
```

In example 3, a single command line argument is provided. The Client Driver will attempt to configure a QSP-100 inserted into socket 0 with a base address of 300H and IRQ 5. If address 300H or IRQ 5 is unavailable, the QSP-100 will not be configured. In addition, if a QSP-100 is inserted into any other socket, it will not be configured. If the Client Driver can successfully configure the QSP-100, its interrupt status register will be enabled and the BIOS equipment list will not be updated.

### 1.1.1.4Example 4

```
DEVICE = C:\QSP-100\QSP100CL.SYS (i5,e,u,b300)
```

In example 4, a single command line argument is provided. Because the parameter order is not significant, the Client Driver will attempt to configure a QSP-100 inserted into any socket with a base address of 300H and IRQ 5. If address 300H or IRQ 5 is unavailable, the QSP-100 will not be configured. If the Client Driver can successfully configure the QSP-100, its interrupt status register will be disabled (Scratchpad registers enabled) and the BIOS equipment list will be updated.

### 1.1.1.5Example 5

```
DEVICE = C:\QSP-100\QSP100CL.SYS (b300,i5) (i10) ( )
```

In example 5, three command line arguments are provided. The Client Driver will first attempt to configure a QSP-100 inserted into any socket with a base address of 300H and IRQ 5. If address 300H or IRQ 5 is unavailable, the Client Driver will proceed to the second command line argument and attempt to configure the card with a base address assigned by Card and Socket Services and IRQ 10. If IRQ 10 is also unavailable, the Client Driver will proceed to the third command line argument and attempt to configure the QSP-100 with a base address and an IRQ assigned by Card and Socket Services. If the QSP-100 is successfully configured, its interrupt status register will be enabled and the BIOS equipment list will not be updated.

### 1.1.1.6 Example 6

```
DEVICE = C:\QSP-100\QSP100CL.SYS (b300,i5) ( ) (i10)
```

In example 6, the three command line arguments of example 5 have been re-arranged. The Client Driver will first attempt to configure a QSP-100 inserted into any socket with a base address of 300H and IRQ 5. If address 300H or IRQ 5 is unavailable, the Client Driver will proceed to the second command line argument and attempt to configure the card with a base address and IRQ assigned by Card and Socket Services. Since the second command line argument includes all available address and IRQ resources, the third command line argument will never be reached by the Client Driver. It is the user's responsibility to place the command line arguments in a logical order.

### 1.1.1.7 Example 7

```
DEVICE = C:\QSP-100\QSP100CL.SYS (s0,b300,i5) (s1,b340,i10)
```

The type of configuration shown in example 7 may be desirable in systems where more than one QSP-100 is to be installed. In this example, the Client Driver will attempt to configure a QSP-100 inserted into socket 0 with a base address of 300H and IRQ 5. If the QSP-100 is inserted into socket 1, the Client Driver will attempt to configure it with base address 340H and IRQ 10. This allows the user to force the QSP-100's address and IRQ settings to be socket specific which may simplify cable connections and software development. As in the previous examples, however, if the requested address or interrupt resources are not available, the QSP-100 will not be configured.

## 2.5 Common Problems

### **Generic Client Drivers:**

Many Card and Socket Services packages include a generic client driver (or SuperClient) which configures standard I/O devices. If one of these generic client drivers is installed, it may configure the QSP-100 causing the QSP-100 client driver to fail installation. In these cases, the user should do one of the following:

1. modify the operation of the generic client driver to disable the configuration of modem/serial port cards. Consult the Card and Socket Services documentation for availability and details of this feature.
2. place the QSP-100 client driver before the generic client driver in the CONFIG.SYS.

### **Available Resources:**

One function of the Card and Socket Services software is to track which system resources (memory addresses, I/O addresses, IRQs, etc.) are available for assignment to inserted PCMCIA cards. Sometimes, however, the Card Services software assumes or incorrectly determines that a particular resource is used when it is actually available. Most Card and Socket Services generate a resource table in a file (typically in the form of an .INI file) which the user can modify to adjust the available system resources. Consult the Card and Socket Services documentation for availability and details of this feature.

### **Multiple Configuration Attempts:**

Some Card and Socket Services have a setting which aborts the configuration process after a single configuration failure (such as a request for an unavailable resource). The user should change this setting to allow for multiple configuration attempts. Consult the Card and Socket Services documentation for availability and details of this feature.

### **Older Versions of Card and Socket Services:**

Some versions of Card and Socket Services dated before 1993 do not support general purpose I/O cards. If after careful installation of the Client Driver the QSP-100 does not configure or operate properly, an updated version of Card and Socket Services may be required. Card and Socket Services software is available from Quatech Inc.

## 2.6 QSP-100 Enabler for DOS

For systems that are not operating PCMCIA Card and Socket Services software, the QSP-100 DOS Enabler may be used to enable and configure the adapter. This Enabler, QSP100EN.EXE, will operate

on any DOS system using an Intel 82365SL or PCIC compatible PCMCIA host adapter including the Cirrus Logic CL-PD6710 / 6720, the VLSI VL82C146, and the Vadem VG-365 among others.

**IMPORTANT:**

In order to use the QSP-100 Enabler for DOS, the system **MUST NOT** be configured with Card and Socket Services software. If a Card and Socket Services software is installed, the QSP-100 Enabler may interfere with its operation and with the device(s) it controls.

The QSP-100 Enabler does not support automatic configuration of adapters upon insertion, more commonly referred to as "Hot Swapping". This means the adapter must be installed in one of the system's PCMCIA sockets before executing QSP100EN.EXE. If more than one adapter is installed in a system, the Enabler must be executed separately for each adapter. Furthermore, QSP100EN.EXE should be executed to release the resources used by the adapter before it is removed from the PCMCIA socket. Since PCMCIA adapters do not retain their configuration after removal, any adapter that is removed from the system must be re-configured with the Enabler after re-inserting it into a PCMCIA socket.

**IMPORTANT:**

The Enabler requires a region of high DOS memory when configuring a QSP-100. This region is 1000H bytes (4KB) long and by default begins at address D0000H (the default address may be changed using the "W" option). If a memory manager such as EMM386, QEMM, or 386Max is installed on the system, this region of DOS memory must be excluded from the memory manager's control. Consult the documentation provided with the memory manager software for instructions on how to exclude this memory region.

## 2.7 Command Line Options

To configure a QSP-100 in the system, the Enabler requires one command line argument from the user to determine the configuration of the card. This argument must be enclosed in parenthesis and within the argument, any or all of the following parameters may be specified using a comma (no spaces) to separate each parameter:

- Ssocket* specifies which PCMCIA socket the QSP-100 must be inserted into for this configuration argument to be used. *socket* must be in the range 0 - 15. This option is always required.
- Baddress* specifies the base I/O address of the QSP-100 in hexadecimal and must reside on an even 32-byte (20H) boundary. This option is required if the 'R' option is not used.
- Iirq* specifies the interrupt level (IRQ) of the QSP-100 in decimal. *irq* must be one of the following values: 3, 4, 5, 7, 9, 10, 11, 12, 14, 15, or 0 if no IRQ is desired. This option is required if the 'R' option is not used.
- Waddress* specifies the base address of the memory window required to configure the QSP-100. Set *address* = D0 for a memory window at segment D000, *address* = D8 for a memory window at segment D800, etc. Valid settings for *address* are C8, CC, D0, D4, D8, and DC. If this option is omitted, a memory window at segment D000 will be used.
- U instructs the Enabler to disable the QSP-100's interrupt status register and enable the Scratchpad registers of the individual UARTs. This option is only required in very rare cases where an application program requires access to the UART's Scratchpad register. If this option is omitted, the QSP-100's interrupt status register is enabled and the UARTs' Scratchpad registers are disabled.
- E instructs the Enabler to update the BIOS equipment list with the addresses assigned to the QSP-100. This option is only required in very rare cases where an application program checks the BIOS equipment list to determine the address of a COM port. If this option is omitted, the BIOS equipment list is not updated.

Before removing a QSP-100 from its PCMCIA socket, the Enabler should be executed to free the system resources allocated when the card was installed. For this operation the Enabler provides an additional command line option:

R instructs the Client Driver to release the resources previously allocated to the QSP-100. When the 'R' option is used, any settings specified by the 'B', 'I', 'U', and 'E' options are ignored. This option **must** be omitted when installing a QSP-100 into the system.

#### 1.1.1.1 Example 1

```
QSP100EN.EXE
```

In example 1, no command line argument is specified. The Enabler will report an error and display the proper usage of the command.

#### 1.1.1.2 Example 2

```
QSP100EN.EXE (s0,b300,i5)
```

In example 2, the Enabler will configure the QSP-100 in socket 0 with a base address of 300H and IRQ 5 using a configuration memory window at segment D000. The QSP-100's interrupt status register will be enabled and the BIOS equipment list will not be updated.

#### 1.1.1.3 Example 3

```
QSP100EN.EXE (i10,e,u,b340,s1)
```

In example 3, the Enabler will configure the QSP-100 in socket 1 with a base address of 340H and IRQ 10 using a configuration memory window at segment D000. The QSP-100's interrupt status register will be disabled (Scratchpad registers enabled) and the BIOS equipment list will be updated. Note that the parameter order is not significant.

#### 1.1.1.4 Example 4

QSP100EN.EXE (s0,b300,i3,wd8)

In example 4, the Enabler will configure the QSP-100 in socket 0 with a base address of 300H and IRQ 3 using a configuration memory window at segment D800. The QSP-100's interrupt status register will be enabled and the BIOS equipment list will not be updated.

#### 1.1.1.5 Example 5

QSP100EN.EXE (s0,b300,i5,r)

In example 5, the Enabler will release the configuration used by the QSP-100 in socket 0 using a configuration memory window at segment D000. The base address and IRQ parameters are ignored and may be omitted.

#### 1.1.1.6 Example 6

QSP100EN.EXE (s1,r,wcc)

In example 5, the Enabler will release the configuration used by the QSP-100 in socket 1 using a configuration memory window at segment CC00.

## 2.8 Common Problems

### **Memory Range Exclusion:**

The Enabler requires a region of high DOS memory when configuring a QSP-100. This region is 1000H bytes (4KB) long and by default begins at address D0000H (the default address may be changed using the "W" option). If a memory manager such as EMM386, QEMM, or 386Max is installed on the system, this region of DOS memory must be excluded from the memory manager's control. Consult the documentation provided with the memory manager software for instructions on how to exclude this memory region.

Furthermore, some systems use the high memory area for BIOS shadowing to improve overall system performance. In order for the Enabler to operate, any BIOS shadowing must be disabled in the address range specified for the configuration window. BIOS shadowing can usually be disabled through the system's CMOS setup utility.

### **Socket Numbers:**

The Enabler requires the QSP-100's socket number to be specified on the command line and the QSP-100 must be inserted into the socket before the Enabler is invoked. Some vendors number their sockets from 1 to N while other vendors number their sockets from 0 to N-1. For the QSP-100 Enabler, the lowest socket number in the system is designated socket 0.

### **Card and Socket Services Software:**

In order to use the QSP-100 Enabler for DOS, the system **MUST NOT** be configured with Card and Socket Services software. If a Card and Socket Services software is installed, the QSP-100 Enabler may interfere with its operation and with the device(s) it controls. For systems configured with Card and Socket Services, the QSP-100 Client Driver is the recommended method of configuration.

### 3. OS/2 Installation

---

In order to use the QSP-100 Client Driver for OS/2, the system must be configured as follows:

1. The system must be running OS/2 2.1 or later.
2. OS/2 PCMCIA Card and Socket Services support must be installed. If PCMCIA support was not selected when OS/2 was installed, it can be added using the Selective Install facility in the System Setup folder. On OS/2 2.1 and 2.11, Socket Services must be added separately. The necessary files can be found on Compuserve in the OS2SUPPORT forum and may be available elsewhere. These files are not available from Quatech Inc.
3. Quatech's OS/2 serial port device driver, "QCOM" version 2.01 or later, must be installed. The QSP-100 will not operate with the standard OS/2 serial port device drivers. Quatech Inc. can not guarantee the operation of the QSP-100 with any other third party device drivers for OS/2.
4. There must be at least 32 bytes of available I/O space and 1 available IRQ.

After the system has been configured to the above specifications, the QSP-100 Client Driver may be installed with the following procedure:

1. Copy the QSP100.SYS client driver file from the distribution Quatech COM CD to any convenient directory on the hard disk.
2. Open the CONFIG.SYS file using any ASCII text editor.
3. Add the following line to the CONFIG.SYS file:  

```
DEVICE =  
drive:\path\QSP100.SYS options
```

where *options* are the QSP-100 OS/2 Client Driver command line options discussed in the following sections.
4. Save the CONFIG.SYS file, exit the text editor, shutdown the system, and reboot to activate the changes.

## 3.1 Command Line Options

The QSP-100 Client Driver for OS/2 supports two methods of configuration: using "system assigned" resources and using "user assigned" resources. Both options provide full PCMCIA compliance and functionality (including "Hot-swapping") but each has some advantages and disadvantages as discussed in the following sections.

## 3.2 Configuring With "System Assigned" Resources

Allowing the OS/2 Plug-and-Play system to assign the hardware resources to the QSP-100 is the ideal choice when only OS/2 programs will access the serial ports. When configuring the hardware, the user simply specifies a list of COM port numbers. When a QSP-100 is inserted into a PCMCIA socket, the client driver will configure the card as a series of COM ports, starting with the lowest available port number in the list.

Configuring a QSP-100 with system assigned resources can be a problem, however, if DOS and/or Windows applications will be accessing the serial ports. This is because most DOS applications write directly to the communications hardware and the Windows' Control Panel also wants to know the hardware configuration of the serial ports. In these cases, the user may want to configure the QSP-100 with "user assigned" resources.

### 1.1.1.1 Example 1

```
DEVICE=C:\QSP-100\QSP100.SYS COM3
```

In example 1, the Client Driver will attempt to configure the QSP-100 as COM3 through COM6. If COM3, 4, 5, or 6 already exists in the system, the QSP-100 will not be configured. Furthermore, only one QSP-100 can be installed in this system.

### 1.1.1.2 Example 2

```
DEVICE=C:\QSP-100\QSP100.SYS COM7 COM3
```

In example 2, the Client Driver will attempt to configure the QSP-100 as COM3 through COM6. If COM3, 4, 5, or 6 already exists in the system, the Client Driver will attempt to configure the QSP-100 as COM7 through COM10. If COM7, 8, 9, or 10 already exist in the system, the QSP-100 will not be configured. Up to two QSP-100s can be installed in this system.

### 3.3 Configuring With "User Assigned" Resources

As mentioned in the previous section, allowing the OS/2 Plug-and-Play system to assign the hardware resources to the QSP-100 is ideal for OS/2 programs but can be a problem if DOS and/or Windows applications will be accessing the serial ports. This is because most DOS applications write directly to the communications hardware and the Windows' Control Panel also wants to know the hardware configuration of the serial ports. For this reason, the QSP-100 Client Driver allows the user to request specific hardware settings using a series of command line arguments of the form

(port,address,irq)

port	specifies the beginning COM port number
address	specifies the base I/O address of the QSP-100 in hexadecimal and must reside on an even 32-byte (20H) boundary.
irq	specifies the interrupt level (IRQ) of the QSP-100 in decimal. <i>irq</i> must be one of the following values: 3, 4, 5, 7, 9, 10, 11, 12, 14, or 15.

Each argument must be enclosed in parentheses and must be separated from other arguments by a space on the command line. Within each argument, the parameters must be separated using a comma (no spaces).

When a QSP-100 is inserted into a PCMCIA socket, the client driver will configure the card as a series of COM ports, starting with the lowest available port number in the list.

#### **IMPORTANT:**

If the user specified resources are in-use by other devices in the system, the QSP-100 will not be configured.

#### 1.1.1.1 Example 1

```
DEVICE=C:\QSP-100\QSP100.SYS (3,100,5)
```

In example 1, the Client Driver will attempt to configure the QSP-100 as COM3 through COM6 using I/O addresses 100-11F hex and IRQ 5. If COM3, 4, 5, or 6 already exists, or if the I/O address or IRQ resources are already in use, the QSP-100 will not be configured. Furthermore, only one QSP-100 can be installed in this system.

#### 1.1.1.2 Example 2

```
DEVICE=C:\QSP-100\QSP100.SYS (7,120,15) (3,300,4)
```

In example 2, the Client Driver will attempt to configure the QSP-100 as COM3 through COM6 using I/O address 300-31F hex and IRQ 4. If COM3, 4, 5, or 6 already exists, or if the I/O address or IRQ resources are already in use, the Client Driver will attempt to configure the QSP-100 as COM7 through COM10 using I/O address 120-13F hex and IRQ 15. If COM7, 8, 9, or 10 already exists or if the I/O address or IRQ resources are already in use, the QSP-100 will not be configured. Up to two QSP-100s can be installed in this system.

### 3.4 Advanced Configuration Topics

For some applications, it may be desirable to specify the resources for one QSP-100 while allowing the OS/2 Plug-and-Play system to assign the hardware resources for any additional cards. This can be accomplished by mixing the configuration methods on the QSP-100 Client Driver command line

```
DEVICE=C:\QSP-100\QSP100.SYS (3,100,5) COM7
```

It is important to remember that when a QSP-100 is inserted into a PCMCIA socket, the client driver will configure the card as a series of COM ports, starting with the lowest available port number in the list.

Another common application requirement is to have a QSP-100 inserted into socket 1 be configured as COM3 through COM6 while a QSP-100 inserted into socket 2 be configured as COM7 through COM10. This type of configuration is supported by appending a "=Sx" parameter **after** any command line argument.

```
DEVICE=C:\QSP-100\QSP100.SYS COM3=S1 COM7=S2  
DEVICE=C:\QSP-100\QSP100.SYS (3,100,4)=S1 (7,300,3)=S2
```

### **3.5 Monitoring The Status Of PCMCIA Cards**

OS/2 Warp provides a utility called "Plug and Play for PCMCIA" that can be used to monitor the status of each PCMCIA socket. In OS/2 2.1, this utility is called "Configuration Manager". When a QSP-100 is inserted, the Card Type for the appropriate socket will display "Multi-Function". If the card is successfully configured, the Card Status will display "Ready". If the card cannot be configured, the Card Status will be "Not Ready". You can view the resources claimed by a configured card by double-clicking on that card's line in the window.

## 3.6 Common Problems

### **Invalid I/O Address When Using OS/2 2.1:**

PCMCIA Card Services for OS/2 2.1 sometimes fails to supply a valid I/O address when using "system assigned" resources. Use the "Configuration Manager" program to examine the I/O address range assigned to the QSP-100. If this range does not begin on an even 32 byte (20H) boundary, the QSP-100 will have to be installed using "user assigned" resources to force a valid configuration.

There have not been any reports of this problem with OS/2 Warp.

### **Resources Not Available:**

When using "user assigned" resources, it is the user's responsibility to ensure the I/O address and IRQ resources are available. For OS/2 Warp users, the RMVIEW utility may be useful in finding resource conflicts. Type "rmview /?" at an OS/2 command prompt for details.

When using "system assigned" resources, if the user knows the port number is available then the system may not have sufficient resources available to configure the QSP-100. Again, the RMVIEW utility provided with OS/2 Warp may be useful in determining the problem.

Regardless of the configuration method, each command line argument specifies the first of four COM ports for the QSP-100. If any of these COM ports are already installed, the Client Driver will not load.

### **Parameter Overlapping:**

When installing the QSP-100, each command line argument specifies the first of four COM ports. If these arguments overlap, the Client Driver will not load. For example, it is illegal to specify QSP100.SYS COM3 COM4 because the first argument requests COM3 - COM6 and the second argument specifies COM4 - COM7.

### **Insufficient Number Of Command Line Arguments:**

The QSP-100 command line must contain at least one command line argument for each QSP-100 to be installed.

## 4. Windows 95 Installation

---

Windows 95 maintains a registry of all known hardware installed within the computer. Inside this hardware registry Windows 95 keeps track of all the computer's resources, such as base I/O addresses, IRQ levels, and DMA channels. In the case of a **PC Card (PCMCIA)** type board, Windows 95 configures the new hardware using free resources it finds within the hardware registry, and updates the registry automatically.

Windows 95 handles the QSP-100 as a "parent/child device". The QSP-100 is the "parent device". Each serial port is a "child device" of the "parent device" QSP-100. To allow easy configuration of Quatech's QSP-100, two configuration files have been written for the QSP-100. These files are called **"INF"** files. The **"QSP-100.INF"** file describes the resources of the QSP-100 parent device. It also indicates the number of child devices. There are 4 child COM ports for the QSP-100. The **"MLTPT\_SP.INF"** file describes the settings for each serial port including all the necessary device drivers.

Windows 95 allows changes in the system resources if the default choices are unacceptable. But first, allow Windows 95 to configure all of the devices. Since the child COM ports are dependent on the parent devices resource allocations, the resources can only be modified at the parent device. Changing these resources is an easy task described in a later section.

### 4.1 Installing a Quatech QSP-100 Under Windows 95.

1. Insert the QSP-100 into any available PC Card socket.
2. The first time a new PC Card type is installed the **New Hardware Found** window opens. After this first installation Windows 95 will automatically detect and configure the card. If the **New Hardware Found** window does not open, then skip to the next section, "Viewing the QSP-100 Settings".
3. The **New Hardware Found** window provides several options to configure the QSP-100 card. Click the **"Driver from Disk"** option button. Click "OK" to continue.
4. An **"Install from Disk"** dialog box should appear. Insert the Quatech COM CD with the **"QSP-100.INF"** file, the **"MLTPT\_SP.INF"**, and the **"SERIALQOT.VXD"** file into the disk drive, select the correct drive letter and path, and click "OK". Windows 95 will browse the path for the aforementioned files.
5. During the installation process, it may be required to supply the computer with the Windows 95 CD or installation diskettes. The QSP-100's child

devices will require the file "**SERIALUI.DLL**". Insert the CD or diskette and click "OK".

**IMPORTANT NOTE:**

If the user already has these files installed on the computer, or if the installation disks are unavailable, it may not be necessary to supply the computer with the Windows 95 CD or installation diskettes. If prompted for the disks, click "OK". A dialog box with an option to skip will appear. Click the "Skip" button and the files will not be installed. If the latest version of these files exist in the system directory, those files will be used.

6. The QSP-100 PC Card should now be configured. In the future, Windows 95 will automatically recognize and configure the QSP-100.

## 4.2 Viewing the QSP-100 Resource Settings

The following steps detail how to view the resource settings that Windows 95 has allocated for the QSP-100.

1. Double click on the **My Computer** icon located on the Windows 95 desktop. This opens a folder showing various drives, Control Panel, etc.
2. Double click on the **Control Panel** icon. This opens another folder with many different system utilities.
3. Double click on the **System** icon. This opens the "**System Properties**" window.
4. Click on the "**Device Manager**" tab. Double click on the item "**Ports (Com & LPT)**" located within the list of hardware.
5. Double click on any of the items labeled "**Quatech Multi- port(COM x)**" where x represents the logical COM port number. The items labeled "**Quatech Multi-port**" are the child devices of the QSP-100 parent device. Click the "**Resources**" tab at the top of the "**System Properties**" box.
6. The base I/O address and IRQ level displayed here is the base I/O address and IRQ level of the entire parent device. The resources cannot be modified

here. For information on how to change these settings, go to the section labeled "Changing Configuration of the QSP-100".

7. Use the **Logical Com Port** name to access any of the particular serial ports on the QSP-100. This name is required by a Windows 95 application when accessing a particular port.

### 4.3 Changing Configuration of the QSP-100.

To change the hardware configuration of the QSP-100, follow the instructions below.

1. Double click the **My Computer** icon located on the Windows 95 desktop.
2. Double click on the **Control Panel** icon.
3. Double click the **System** icon inside the **Control Panel** folder. This will open the **System Properties** box.
4. Click the **Device Manager** tab located along the top of the **System Properties** box.
5. Double click on the device group "**Quatech Comm Adapters**". The QSP-100 model name should appear in this list. If either the "**Quatech Comm Adapters**" group or the QSP-100 model number does not appear, contact Quatech Technical Support for further assistance.
6. Click on the QSP-100 item and then click on the button labeled "**Properties**".
7. Select the resource which requires a change (I/O range or IRQ) and select "**Change Settings**". Make the desired changes and then click on "OK". A shutdown of the system may be required to allow the settings to change. If prompted for a shutdown, select the option which restarts Windows 95.
8. The QSP-100 will be automatically re-configured to the desired settings.
9. The card is now ready for use.

## 5 Installing QSP-100 under Windows NT

---

### 5.1 Installing QSP-100 Under Windows NT

To allow easy configuration of the QSP-100 the Quatech Device Manager for Windows NT has been written for the hardware. This configuration utility supports the QSP-100 only in block addressing mode.

To begin the installation, open Windows Explorer and search for the 'Setup.exe' command to install the Quatech Device Manager. <See following Windows Explorer figure.> (D:\Serial Port Adapters\Drivers\Windows NT 4.0 for PCI, PCMCIA,ISA). Once the installation is complete an icon will be placed on the desktop.

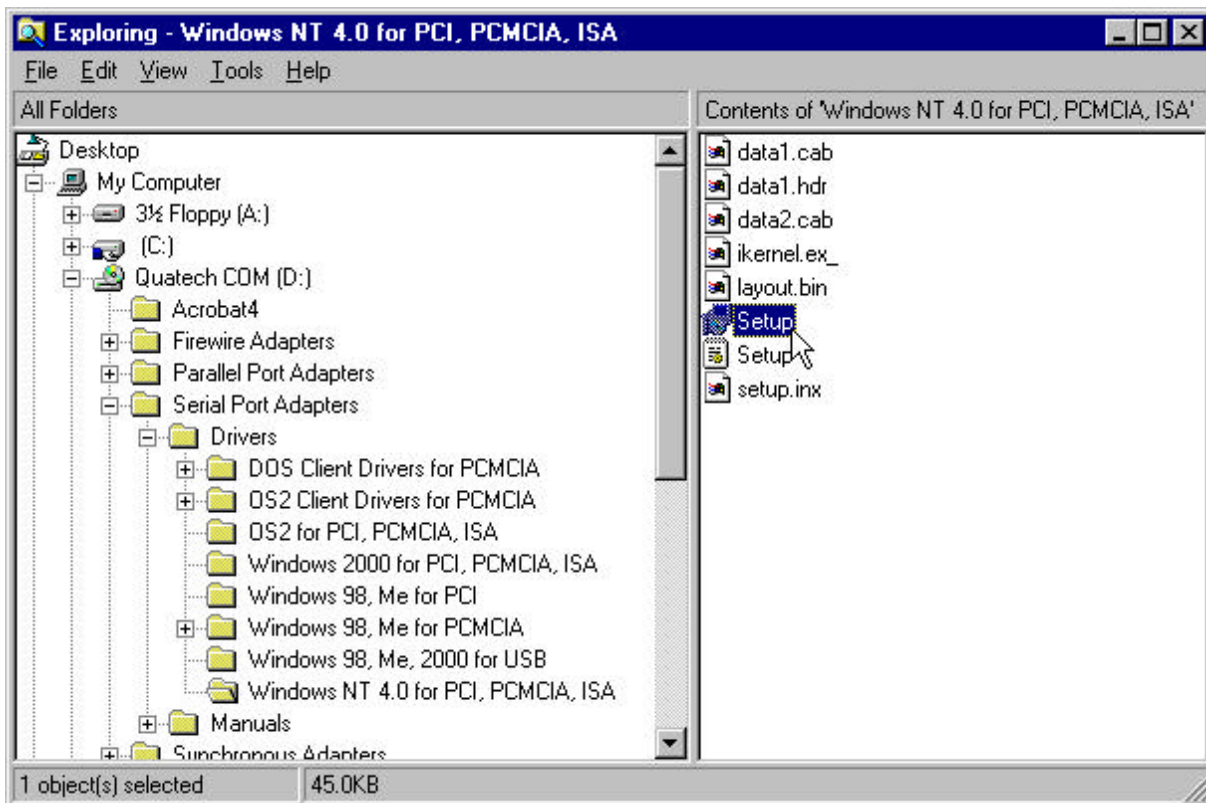

Windows NT Explorer

1. Locate and double click the Quatech Device Manager icon on the desktop.

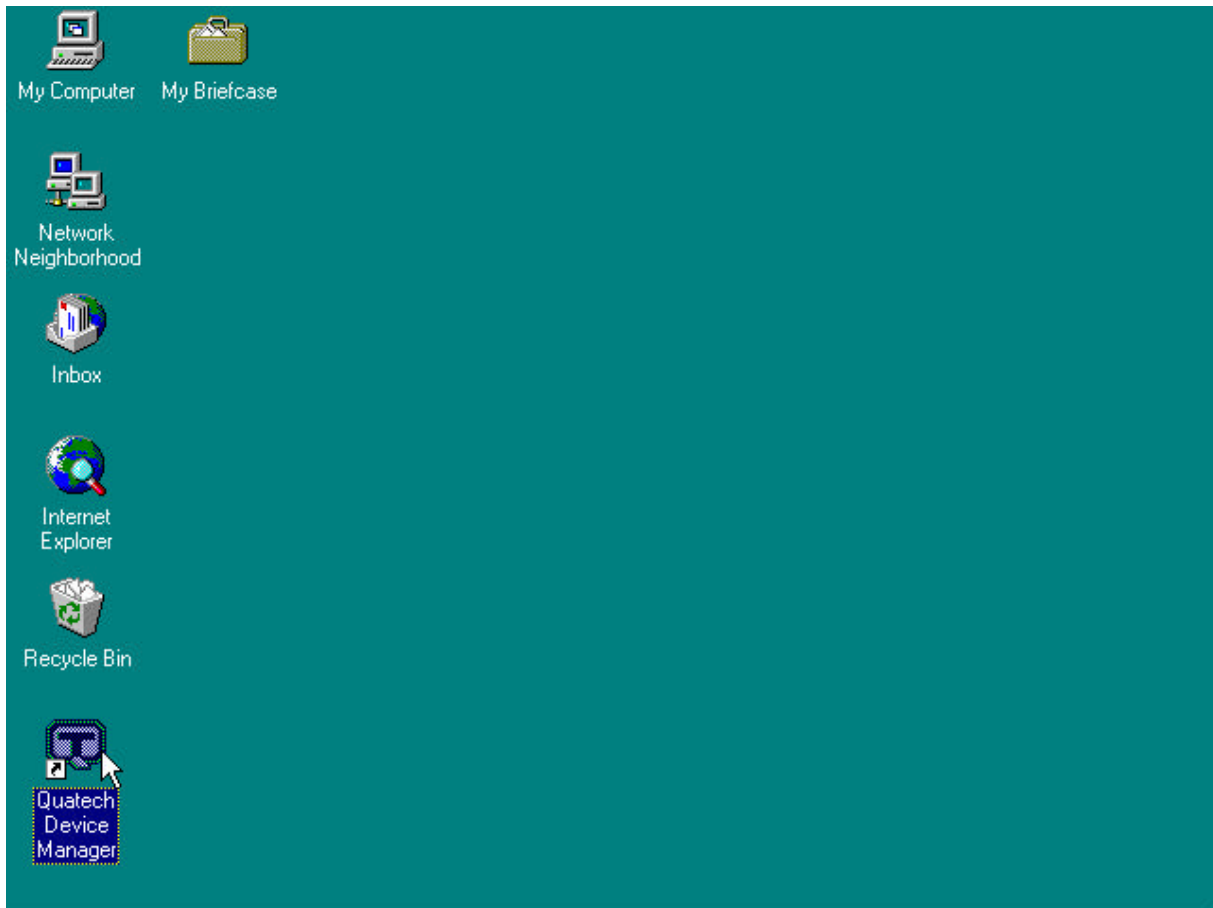

Device Manager Icon on Desktop

2. Click the 'Add' button at the bottom of the Quatech Device Manager Window.



3. Follow the steps for the 'Add Quatech Hardware Wizard'.

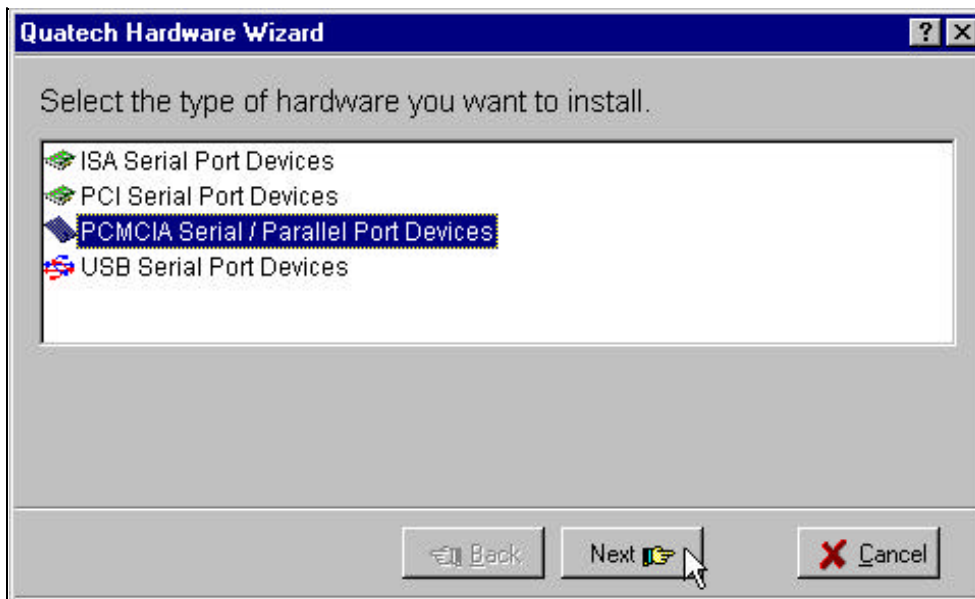

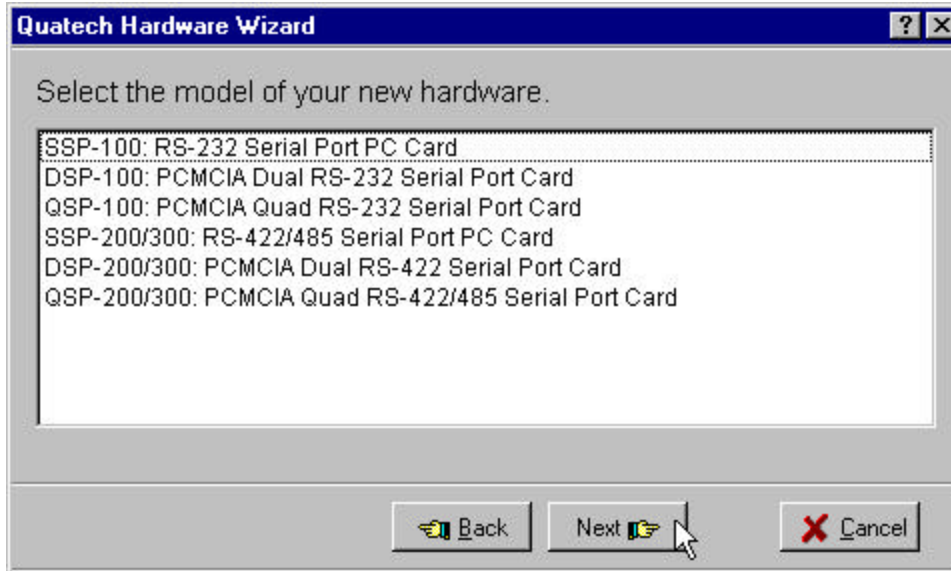

4. Complete the final steps of the installation, insert the PCMCIA Card and re-boot the computer.

▼ Additional help is available online

The DSP-100 PC Card should now be configured. In the future, Windows NT will automatically recognize and configure the QSP-100.

Note: Windows NT does not support 'Plug and Play' for PCMCIA cards. The PCMCIA Card must be inserted prior to starting Windows NT and can not be removed and reinserted while Windows NT is running.

## 6 Windows CE

The Quatech PCMCIA Windows CD installation copies a multiple device-specific .cab files and the ini file to your desktop computer and launches the Application Manger (which resides on the user's desktop computer as a result of installing Active Sync) with the Application Manager .ini file as a parameter. This in turn will install the driver onto the Windows CE connected device or if not connected will install it on the next device connection to the desktop.

### 6.1 Installing Quatech PCMCIA Cards under Windows CE

1. Connect and establish communication to the device to the desk to using Active Sync (refer to Active Sync factory documentation)
2. Locate and run the setup.exe file located in the Windows CE for PCMCIA folder on the Quatech COM CD.

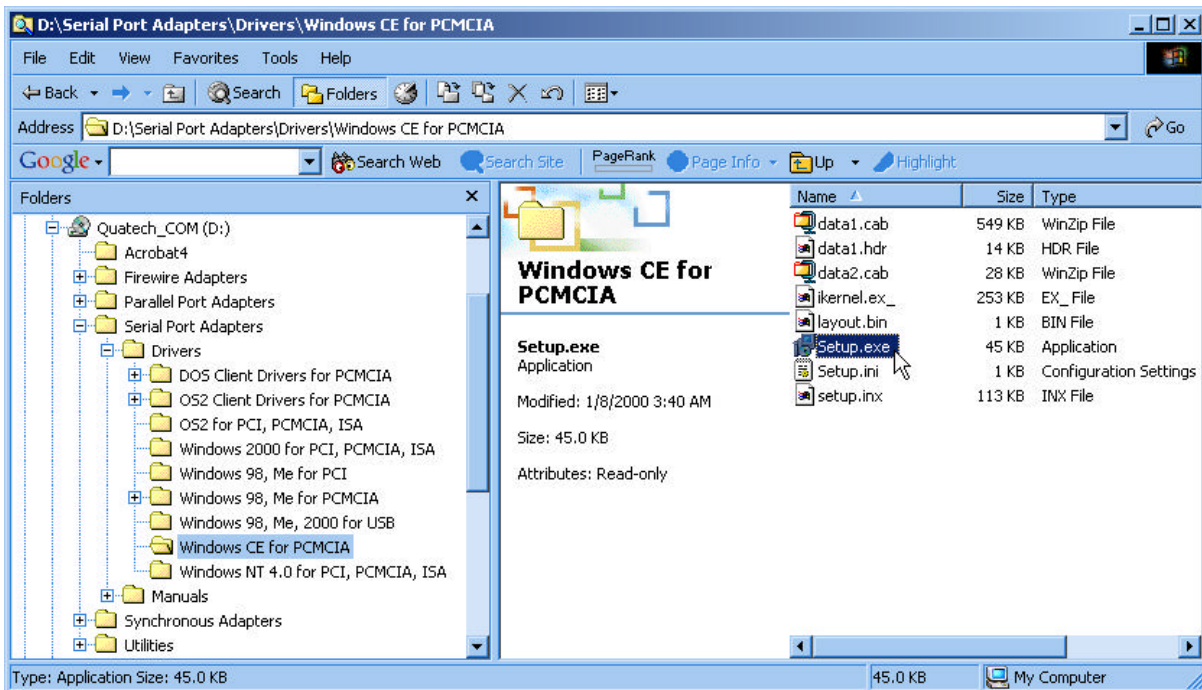

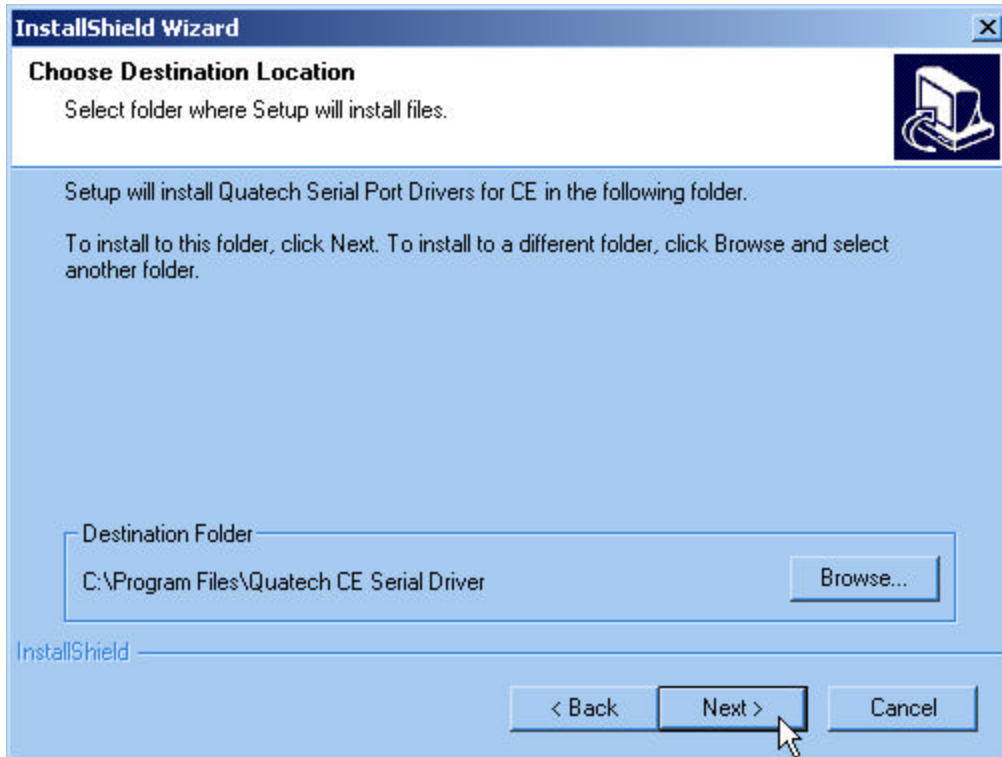

3. The setup program will copy the files to predetermined location, which can be changed by the user. Click next to proceed.. Installation is now complete. In the event that installation process took place with out having the Windows CE device connected to the computer and the install program will prompt the user that

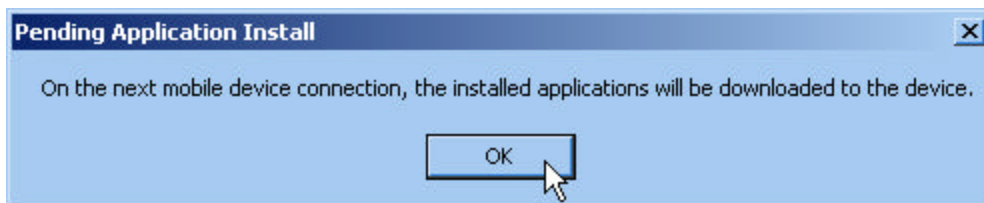

on the next on the next connection the device will complete the installation.

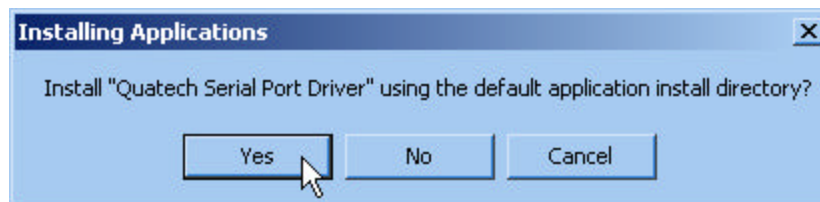

Choose 'Yes' on the following window and you installation is now complete.

## 7. Hardware Information

---

The QSP-100's four asynchronous serial ports are implemented using 4 standard 16C550 UARTs. Each of these UARTs requires 8 bytes of I/O space and when enabled

QSP-100 RS-232 channel	Address assignment
Channel A	Base Address + 0
Channel B	Base Address + 8
Channel C	Base Address + 16
Channel D	Base Address + 24

which requires the QSP-100 to be located on an even 32-byte (20H) boundary (e.g. 300H, 320H, 340H, etc.).

Each 16C550 UART contains 8 I/O registers. The last of these registers, located at (Base address + 7), is referred to as the 'Scratchpad Register' and provides no functionality to the UART. In place of this Scratchpad Register, the QSP-100 implements an interrupt status register which can be accessed at (Base address + 7) of any UART. The purpose of the interrupt status register is to give the software programmer an easy way to inspect the interrupt state of the entire QSP-100 with a single input operation. The format of the interrupt status register is shown below:

D7	D6	D5	D4	D3	D2	D1	D0
0	0	0	0	Intr D	Intr C	Intr B	Intr A

When one or more UARTs have interrupts pending, the associated bit(s) in the interrupt status register are set to logic 1. When all the pending interrupts have been serviced for a specific UART, its interrupt status bit will be cleared to logic 0 automatically. When all the pending interrupts from all UARTs have been serviced, the entire interrupt status register will return logic 0. The application program should not exit its interrupt service routine until all pending interrupts from all channels have been serviced (interrupt status register = 0) or no additional interrupts will be received.

If an application requires the UARTs' Scratchpad Registers, the interrupt status register can be disabled using the "p" option on the QSP-100 Client Driver for DOS or the DOS Enabler command lines.

## 8. EXTERNAL CONNECTIONS

---

An adapter cable is included with the QSP-100 to convert the PCMCIA output connector into 4 standard D-9 male RS-232 connectors as shown in the figure below.

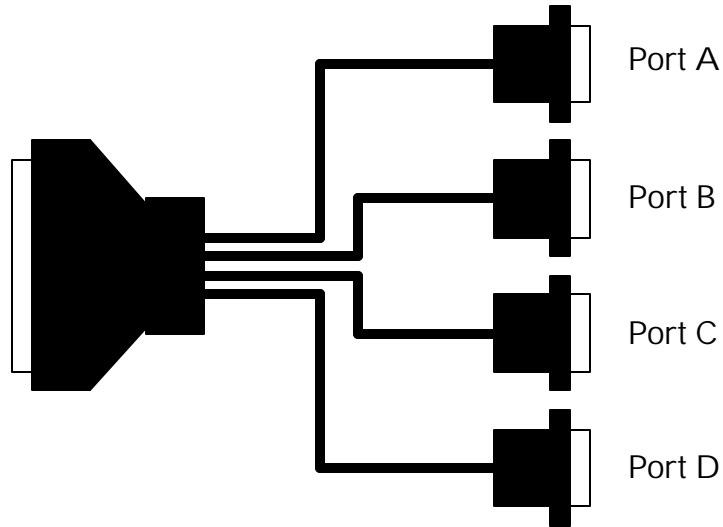

Figure 3. QSP-100 adapter cable to standard RS-232 connectors.

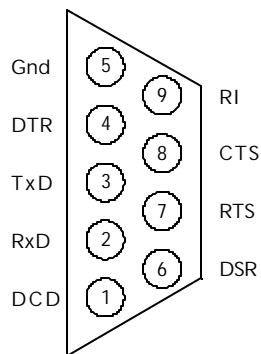

Figure 4. Standard D-9 male RS-232 connector signal assignment.

**This Page Left Blank Intentionally**

## 9. Specifications

---

<b>Bus Interface</b>	PCMCIA PC Card Standard 2.1 compliant
<b>Physical Dimensions</b>	Type II PCMCIA card (5mm)
<b>Maximum Baud Rate</b>	120K
<b>Power Requirements</b>	+5 volts 35.85 mA (typical) 45.87 mA (maximum)
<b>Connector</b>	Adapter to 4 standard male D-9

QSP-100  
User's Manual  
Version 1.41  
July, 2002  
Part No. 940-0102-140